

■ Order by Part Number

Stopper - Polished Stainless
1011



Removable Splash Guard
205497



Sink Flange - Polished Stainless
1017



Mounting Assembly Kit - 1824

Fiber Gasket

Backup Flange

Screws (x3)

Mounting Ring

Snap Ring

Cushion Mount

Lower Mounting Ring

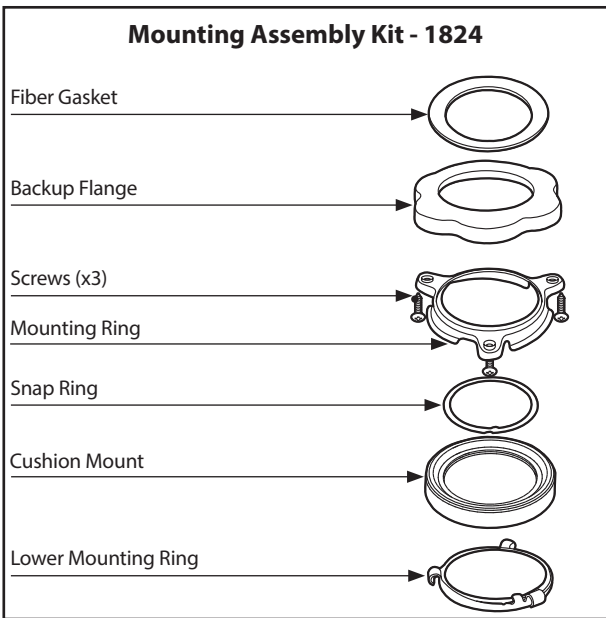

Drain Elbow Kit - 1026

Rubber Gasket

Screws

Drain Elbow

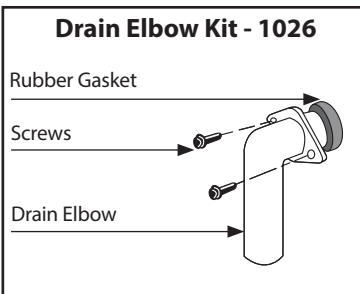

Replacement Power Cord Kit
1024



Illustrated Parts

Garbage Disposals

MODEL GX100c

Other Available Accessories

Air Switch Remote Controller

- Installs into existing sink hole to operate disposer with plunger air switch.
- Perfect application for island countertops or where electrical switch is unavailable.
- No wiring connections or code restrictions.



Air Switch Base Unit	
Air Switch Remote Controller	ARC-4200
Additional Air Switch Button Finish Options:	
Chrome	AS-4201-CH
Satin Nickel	AS-4201-SN
Mediterranean Bronze	AS-4201-BRB
Polished Brass	AS-4201-BR
White	AS-4201-WH
Almond	AS-4201-AL
Biscuit	AS-4201-BIS

Optional:

Dishwasher Connector Kit
1023



Unjamming Wrench
1037

